



1-800-669-9690

BRAKE LIGHT SWITCH BRACKET AND WIRING KIT INSTALLATION INSTRUCTIONS #751437



#85-4346-03 03-15

ALL SPECIFICATIONS ARE SUBJECT TO CHANGE WITHOUT NOTICE

ROADMASTER, Inc. 6110 NE 127th Ave. Vancouver, WA 98682 360-896-0407 fax 360-735-9300 www.roadmasterinc.com

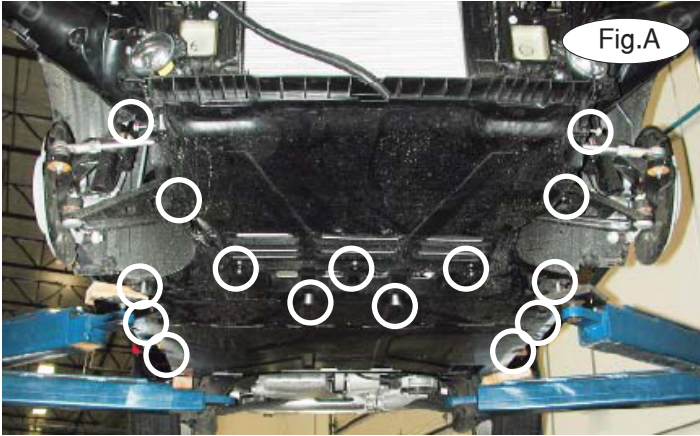

1. Remove the rear part of the belly pan by removing four 10mm (head) bolts on the outside edge. Let the rear part of the belly pan hang down, and then pull out to remove it. Remove the front part of the belly pan by removing eleven 10mm (head) bolts. *Note:* six are located on the outside edges and five are in the middle. The approximate locations of all bolts are noted in Figure A.
2. Remove two 10mm nuts attaching the center splash shield to the body of the vehicle, and remove the shield (Fig.B).

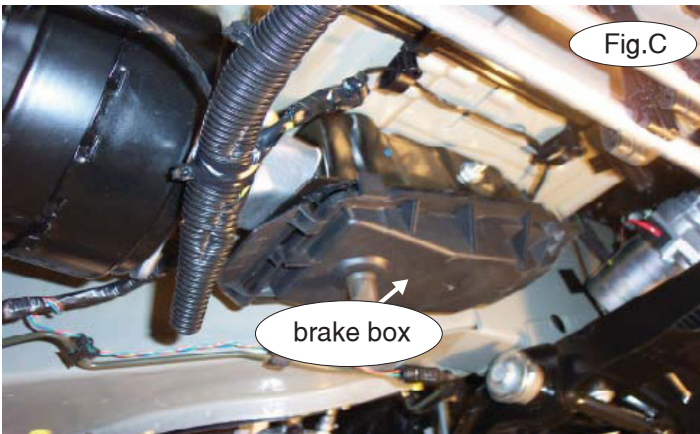

3. Locate the brake box, and pull down on the release to remove the cover (Fig.C).
4. Pull the two clips to remove the wires (Fig.D).
5. Unplug the brake switch by turning it counterclockwise 90 degrees and pulling it out (Fig.E). *Note:* use caution, as this will cause the brake lights to stay on.

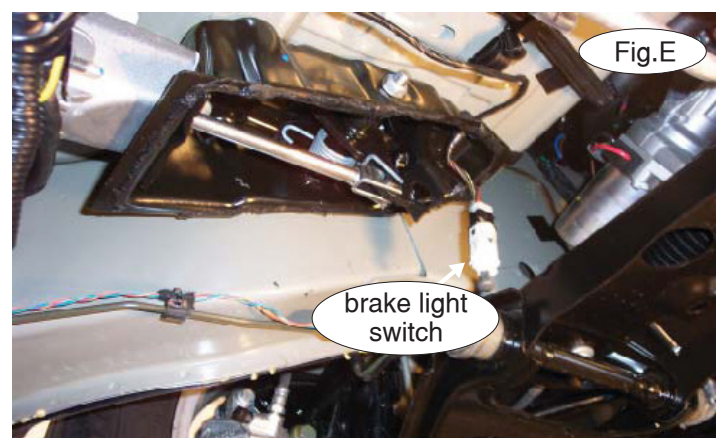

BRAKE LIGHT SWITCH BRACKET AND WIRING KIT INSTALLATION INSTRUCTIONS #751437



#85-4346-03 03-15

ALL SPECIFICATIONS ARE SUBJECT TO CHANGE WITHOUT NOTICE

ROADMASTER, Inc. 6110 NE 127th Ave. Vancouver, WA 98682 360-896-0407 fax 360-735-9300 www.roadmasterinc.com

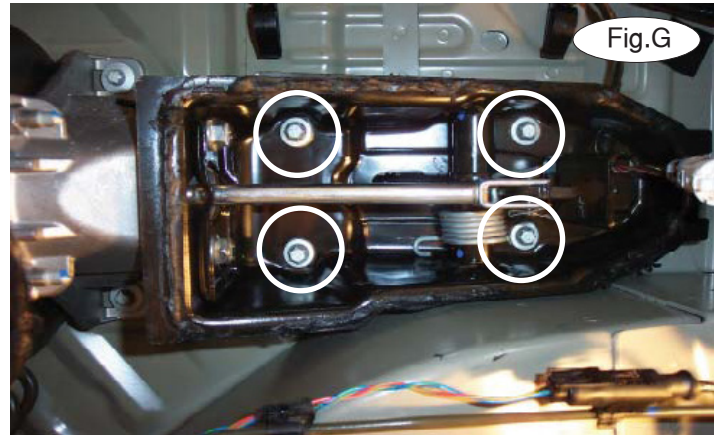
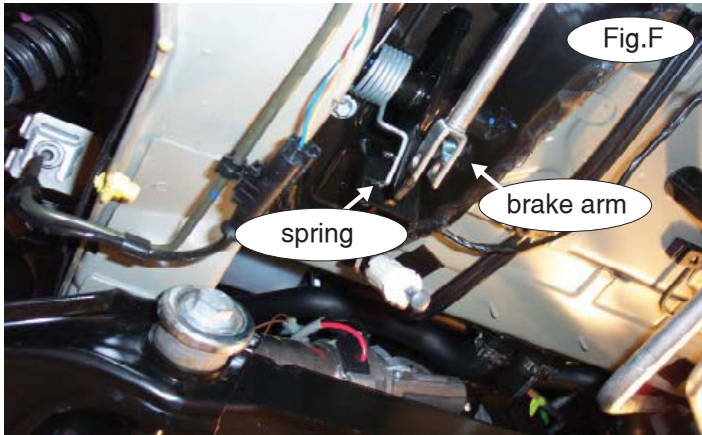

6. Move the spring on the brake arm enough so you can remove the roll pin and then pry the spring over to release its tension (Fig.F).
7. Remove four E12 reverse Torx bolts holding the brake housing assembly to the body (Fig.G).



8. Remove two 13mm (head) bolts attaching the brake housing to the brake master cylinder (Fig.H).
9. Gently pull down on the brake housing and pop it out from the top (Fig.I). This will allow you to pull the housing down about eight inches.
10. Center punch, then drill a 10mm (or 25/64") hole in the brake light switch bracket, which is located directly behind the brake pedal arm (Fig.J).

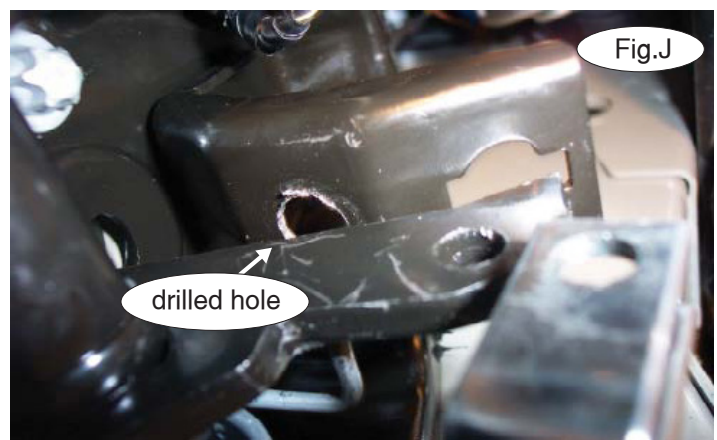



1-800-669-9690

BRAKE LIGHT SWITCH BRACKET AND WIRING KIT INSTALLATION INSTRUCTIONS #751437



#85-4346-03 03-15

ALL SPECIFICATIONS ARE SUBJECT TO CHANGE WITHOUT NOTICE

ROADMASTER, Inc. 6110 NE 127th Ave. Vancouver, WA 98682 360-896-0407 fax 360-735-9300 www.roadmasterinc.com

11. Wire the stop light switch kit according to the instructions provided. Place the stop light switch bracket through the hole you drilled in the previous step. (Fig.K).
12. Reassemble the brake box, reversing steps 1 through 8.
13. From inside the vehicle, reinstall the brake pedal boot by pushing the plastic plate down until it snaps in.
14. Install and wire the stop light switch according to the instructions provided with it. Be certain to adjust as necessary to allow for proper activation of the plunger on the switch. *Note: your stoplight switch may look slightly different than the one shown in the picture.*





Time Tested • Time Proven

855338-02 06.16

ROADMASTER, Inc. • 6110 N.E. 127th Ave. • Vancouver, WA 98682 • 800-669-9690 • Fax 360-735-9300 • roadmasterinc.com

metal Brake Light Switch

part number 300188-00

Installation Instructions

All specifications are subject to change without notice.

Purpose of this kit

This kit is necessary if...

...you are installing a supplemental braking system with a monitor and the brake lights do not function when the vehicle is in the "tow" mode.

...you are installing a supplemental braking system and the vehicle is equipped with a "retained accessory power" feature. (With this feature, the vehicle's electronics continue to function normally for about ten minutes after the ignition is turned off. Then the electronics will no longer function, which shuts off power to the OEM brake light switch.)

Step A – Install the brake light switch

1. Thread the first adjusting nut (Figure A) onto the brake light switch.
2. Slide the threaded side of the brake light switch through the brake light switch mounting bracket.
3. Position the star washer against the bracket.
4. Thread the second adjusting nut onto the brake light switch. (Do not fully tighten the nut at this time.)
5. With the brake light switch in position, attach the mounting bracket – refer to the vehicle-specific instructions that are attached to these instructions.
6. Preliminary adjustment to the brake light switch – make certain that the brake pedal is not depressed. Then turn the adjusting nuts until the white plunger at the end of the brake light switch is completely depressed, as shown in Figure A.

CAUTION

The brake light switch must be installed as directed above. If it is not, it may cause a dashboard error message.

Additionally...

- The plunger must be completely depressed against the brake arm. Otherwise, it may cause a false brake light signal at the monitor.
- The brake pedal must not be depressed when the brake light switch is installed. If it is, the brake pedal may depress the towed vehicle's brakes continuously, which will cause excessive brake wear, brake system damage or other consequential, non-warranty damage.

Step B – Select a power source

Power for the switch can come from either the battery or the fuse block. The fuse block is typically an easier connection.

Option 1 – Power from the fuse block

Identify a fuse that is constantly powered when the

ignition is in the "tow" position. Pull the fuse.

Note: make certain this fuse is not part of a "retained accessory power" circuit – see "Purpose of this kit," above.

Insert the fuse you just pulled into the slot closest to the fuse blades (Figure B), then insert the fuse tap into the empty slot in the fuse box (Figure C).

Proceed to Step C.

continued on next page

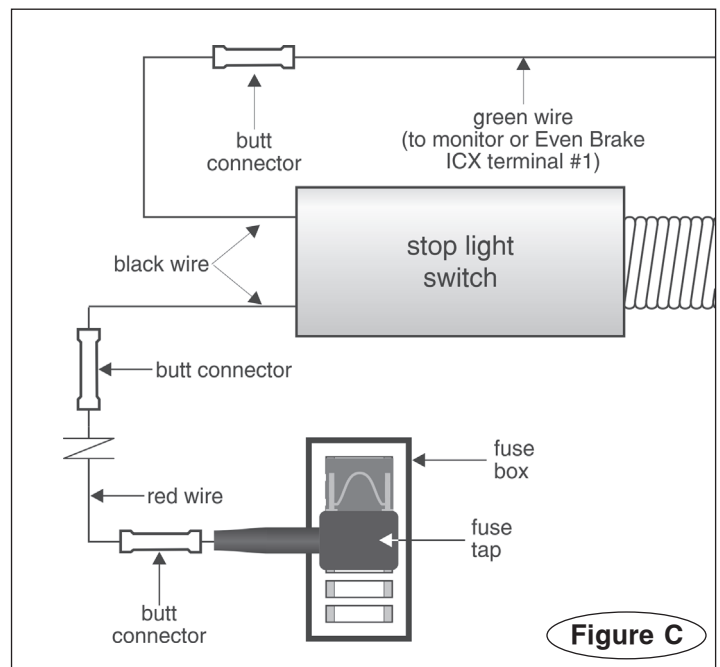
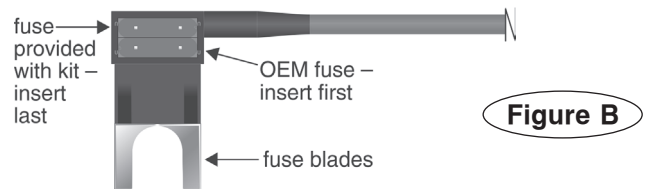
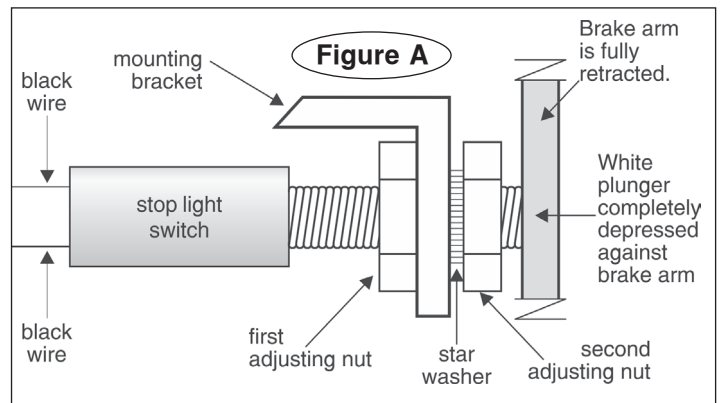

continued from preceding page

Option 2 – Power from the battery

Use the provided ring terminal to connect a fuse holder to the positive terminal on the vehicle's battery (Figure D).

Note: if a fuse holder is included in this kit, the manufacturer has recommended disconnecting the battery of one or more makes of this vehicle to tow.

Note: if the vehicle's battery must be disconnected for towing and a Roadmaster battery disconnect device has been installed, make certain that the ring terminal is connected to the positive side of the battery disconnect device. If it is, then 12VDC+ will be present when the battery is disconnected.

Proceed to Step C.

Step C – Connect to power

1. Use the provided red wire and butt connectors to connect the fuse holder or fuse tap (depending on which power source you chose) to either one of the black wires extending from the brake light switch (Figure C or D).

2. Insert the provided 10-amp fuse into the fuse tap or fuse holder.

Step D – Final adjustment to the brake light switch

1. Attach a circuit tester or volt meter to the other black wire extending from the brake light switch.

2. Rotate the switch in or out until it takes approximately 1/8" of brake pedal travel to register 12VDC+ on your tester.

3. With the vehicle's engine on, verify that the brake lights illuminate properly when the brake pedal is depressed.

Note: if, after installation, the supplemental brake monitor light flickers on and off while towing, readjust the switch.

Note: if the monitor light does not function, check the brake light switch first.

4. Once adjusted, tighten both nuts.

Step E – Wire the switch to the motorhome monitor

1. For Even Brake **only** – connect the green wire to the terminal marked "1" on the Even Brake ICX transmitter (Figure D).

2. For all ROADMASTER braking systems **except** Even Brake – using a butt connector, connect the remaining switch wire to the motorhome monitor wire. Use the green wire if you need to extend the wire length.

Step F – Test for clearance

With the engine on, depress the brake pedal to its farthest extent, then allow it to fully return. Make certain that the brake light switch bracket or other kit components do not impede the full and complete movement of the brake pedal.

WARNING

When the installation is complete, verify that the brake pedal retracts fully.

Unless they are installed correctly, the bracket wiring and/or other kit components may impede the movement of the brake pedal.

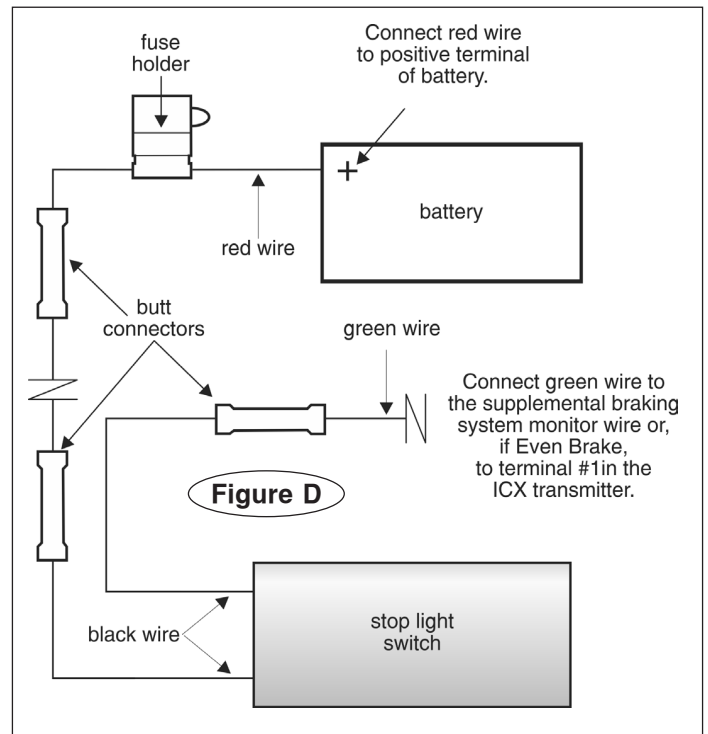

If the brake pedal does not retract fully, the brakes will be applied continuously, which may cause severe tire and/or brake system damage, as well as other consequential, non-warranty damage.

Failure to follow these instructions may cause property damage, personal injury or even death.